

Medieval Manuscripts

BOOKBINDING TERMS,
MATERIALS, METHODS,
AND MODELS

Medieval Manuscripts

BOOKBINDING TERMS,
MATERIALS, METHODS,
AND MODELS

This booklet was compiled by the Special Collections Conservation Unit of the Preservation Department of Yale University Library. If you have any comments or questions, please email Karen Jutzi at karen.jutzi@yale.edu.

A NOTE ON DATES:

The terms Carolingian, Romanesque & Gothic refer not to an absolute range of dates, but to the style of board attachment (and other characteristics).

The date ranges for Carolingian, Romanesque, and Gothic bindings used in this booklet are taken from J.A. Szirmai's *The Archaeology of Medieval Bookbinding* (Aldershot: Ashgate, 1999).

Szirmai describes Carolingian bindings dating from the 8th through the 12th century (*Archaeology*, 100); Romanesque ranging from the second half of the 11th century to the end of the 14th century (*Archaeology*, 142), and Gothic bindings from the early 14th century through the 17th century (though he limits his discussion of Gothic bindings to no later than 1600) (*Archaeology*, 174). This is a rather broad range, as the dates are based on earliest and latest examples.

For comparison, in the syllabus for his 2011 Rare Book School course *Introduction to the History of Bookbinding*, Jan Storm van Leeuwen dates Carolingian bindings from 800-1000; Romanesque from 1000-c.1250, Gothic from 1150-1420, and Renaissance from 1420-1600 (*Syllabus* 2011, 71-72). I consider these dates to be the peak range when the style was most prevalent.

Table of Contents

MATERIALS OF MEDIEVAL BOOKBINDING

Wood	8
Leather	9
Alum-tawed skin	10
Parchment & vellum	11

TERMINOLOGY

Parts of a medieval book	14
Outside structure	15
Inside structure	16
Bindery tools & equipment	17
Sewing & supports	18

CAROLINGIAN BINDINGS

Characteristics	20
Binding Steps	21

ROMANESQUE BINDINGS

Characteristics	24
Binding Steps	25
MS 4—Romanesque/Gothic	26

GOTHIC BINDINGS

Characteristics	28
Binding Steps	29
MS 84—girdle book	31

LIMP BINDINGS

MS 610—limp parchment (laced)	34
MS 649—limp parchment (tacketed)	35

BIBLIOGRAPHY

37

Materials

Wood

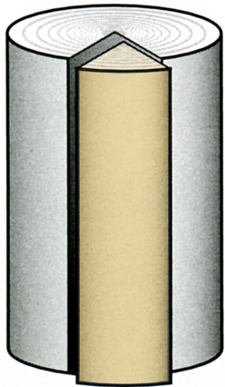

Quarter-cut

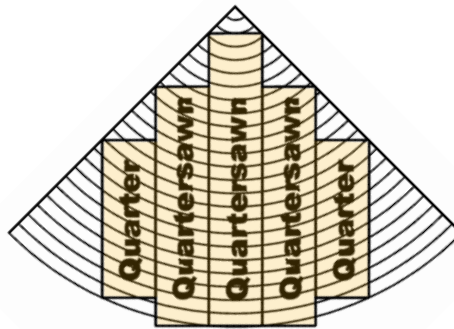

Planks cut radially

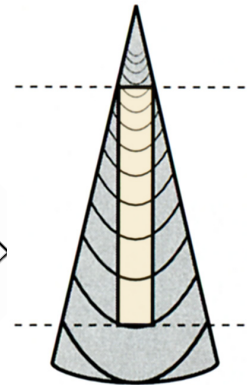

Quarter-sawn
Wood for book cover

Boards for bookbinding were traditionally quarter-sawn. The growth rings in quarter-sawn wood run mostly perpendicular to the surface of the board, which makes the wood less likely to warp or shrink from moisture or changes in humidity.

The process of quarter sawing was to cut the log lengthwise into four wedged-shaped pieces. The wedges were then tipped on their points and the boards were sawn along the axis (see illustration above).

In England, the predominant wood used in bookbinding was oak; beech was common in Italy. Oak and beech were the most common woods used on the Continent, but birch, lime, chestnut, maple, poplar, plane, pinewood and walnut have all been used at one time or another (Szirmai 1999, 103, 151, 216).

Leather

The process of making leather is called tanning. The word derives from the use of tannins—from the Medieval Latin *tannare* (“tan, dye, a tawny color”) and *tannum* (“crushed oak bark”), probably from the Celtic word *tann* (“oak tree”). Tannins were traditionally derived from crushed oak bark.

The skin was soaked in water, then placed in a solution of lime. This loosened the hair and other bits, which could then be scraped off over a beam of wood with a blunt knife. The liming process also swelled and loosened the fiber structure (Vest 2000, 16-17). The skin side was scraped to clean it and level it out. The grain side was scraped with a knife to remove any remaining hair, lime, grease or dirt, then trimmed of unwanted pieces. The scraping process was called “scudding.”

The skin might then be “bated” (immersed in warm water and dog dung) or “puered” (which used bird droppings instead of dog dung), which, after another round of scudding, produced a very smooth grain. “Bran drenching” was sometimes used instead of bating/puering: the skin was soaked in a warm solution of barley or rye and stale beer or urine, which neutralized any remaining lime in addition to softening the skin (Burns 2011).

After another washing, the hide could either be tanned, tawed, or made into parchment.

The tanning process began by soaking the hides in the tanning solution (in England, crushed oak bark and water). This was done in pits. The skins were constantly moved around in the pits to ensure the tannins (and thus the color) spread evenly. The hides would then be layered with ground oak bark, the pits were filled with a weak tanning solution, and the hides were left for up to a year (Burns).

At the end of the tanning process, the hides were rinsed, smoothed, and left in a dark place to dry slowly. The leather was then staked (the flesh side was stretched and pulled over a blunt metal or wooden edge—see *Alum-tawed skin* illustration), shaved to the desired thickness, and greases were applied to make it supple.



Scudding

Note bindings in cupboard, and the tub used to soak skins.

Die Hausbücher der Nürnberger
Zwölfbrüderstiftungen.

Amb. 317b.2° Folio 77 recto (Mendel II)
Stadtbibliothek Nürnberg

Alum-tawed skin

Also called white-tawed or whittawed skin.

The process of tawing skin began with the same steps as tanning leather or making parchment: the skin was soaked in lime, scraped over a beam of wood with a blunt knife, bated or puered or brandrenched, and washed again. The skin was now ready to be tawed.

A tawing paste made with water, alum, salt, egg yolk, and flour was mechanically worked into the wet, dehaired pelt (Vest). Once the paste solution was absorbed by the skin, it was hung up to dry for several weeks (this was called “crusting”).

Once dry, the skin was stiff and inflexible. The final step was staking (as portrayed on the right), which softened the skin and left it brilliantly white and stretchy.



Staking

Note skins drying in background.

Die Hausbücher der Nürnberger
Zwölfbrüderstiftungen

Amb. 317b.2° (Mendel II)
Stadtbibliothek Nürnberg

Parchment & Vellum

The terms parchment & vellum are often used interchangeably, but historically parchment was made from split sheepskin, while vellum (from the Old French *velin*, from *vel*, *veel* “calf”) was made from calfskin.

The same initial steps of tanning and tawing were followed, to de-hair and clean the skin. After a final washing, the skin was stretched on a frame and scraped with a crescent-shaped knife called a *lunarium* to remove additional flesh. The stretched skin was left to dry, after which it was thinned further by sanding.

Parchment and vellum are very sensitive to moisture and fluctuations in humidity levels. The clasps and wooden boards of medieval bindings served to compress and restrain the parchment during these fluctuations.



Scraping

Die Hausbücher der Nürnberger
Zwölfbrüderstiftungen.

Amb. 317.2° Folio 34 verso (Mendel I)
Stadtbibliothek Nürnberg

Terminology

Parts of a medieval book

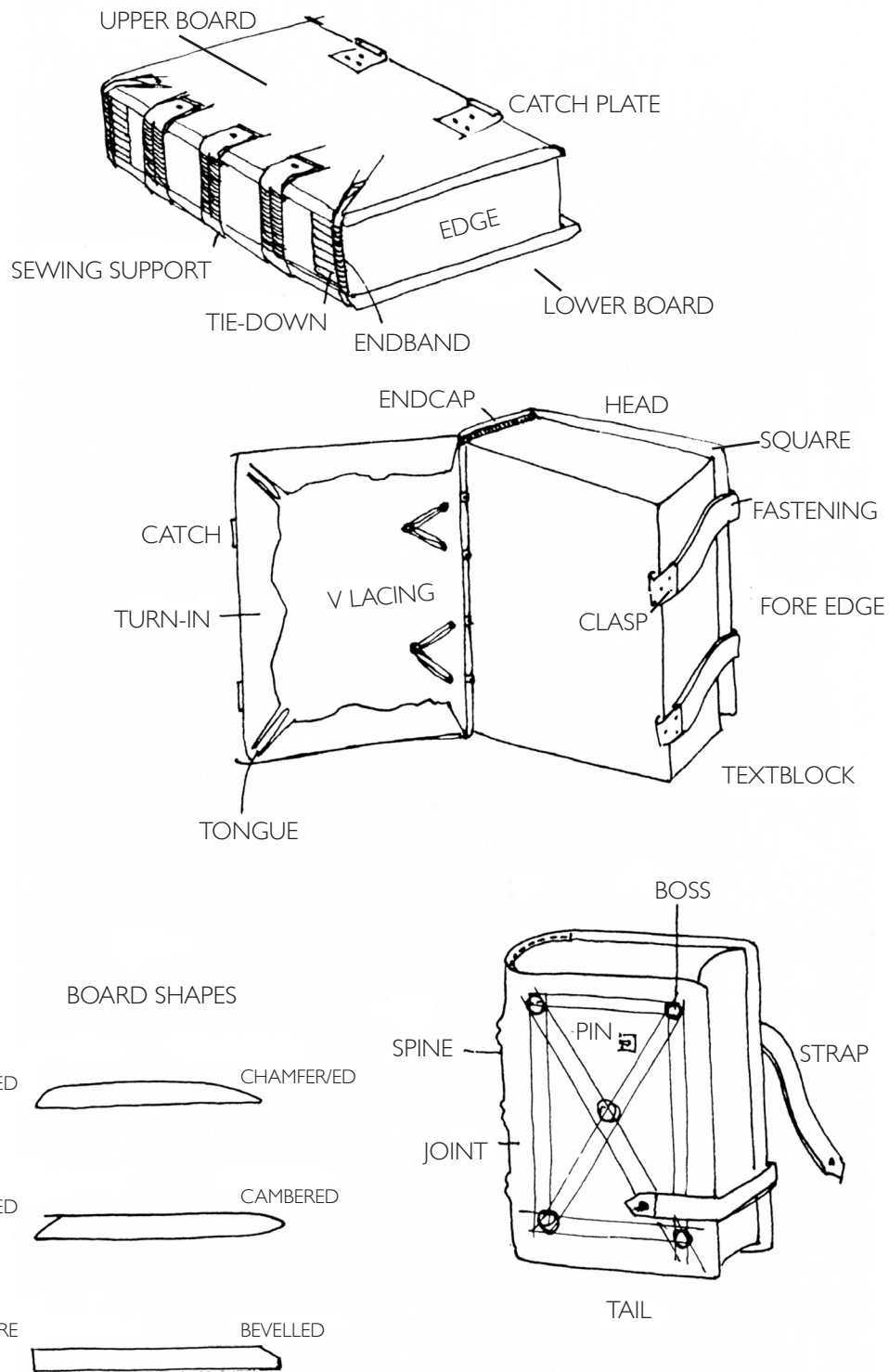

Drawings by Jane Greenfield from *Catalogue of Medieval and Renaissance Manuscripts in the Beinecke Rare Book and Manuscript Library, Yale University, Volume I: MSS 1-250*, by Barbara Shailor.

Outside structure



Inside structure

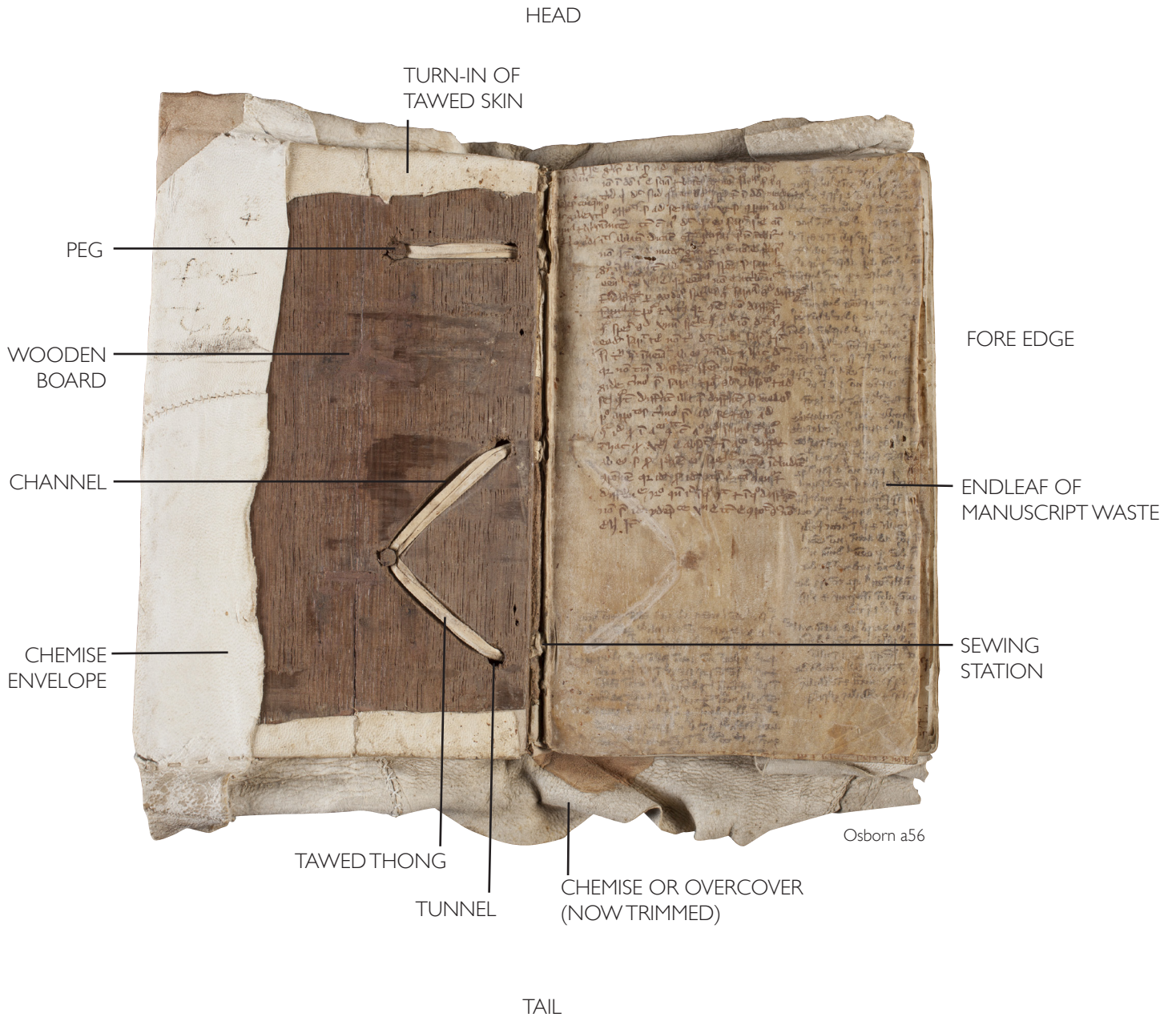

Bindery tools

FROM THE BOOK OF TRADES

BY JOST AMMAN & HANS SACHS (1568)

Though a depiction of a Renaissance bindery, many of these tools were also used in the Middle Ages.

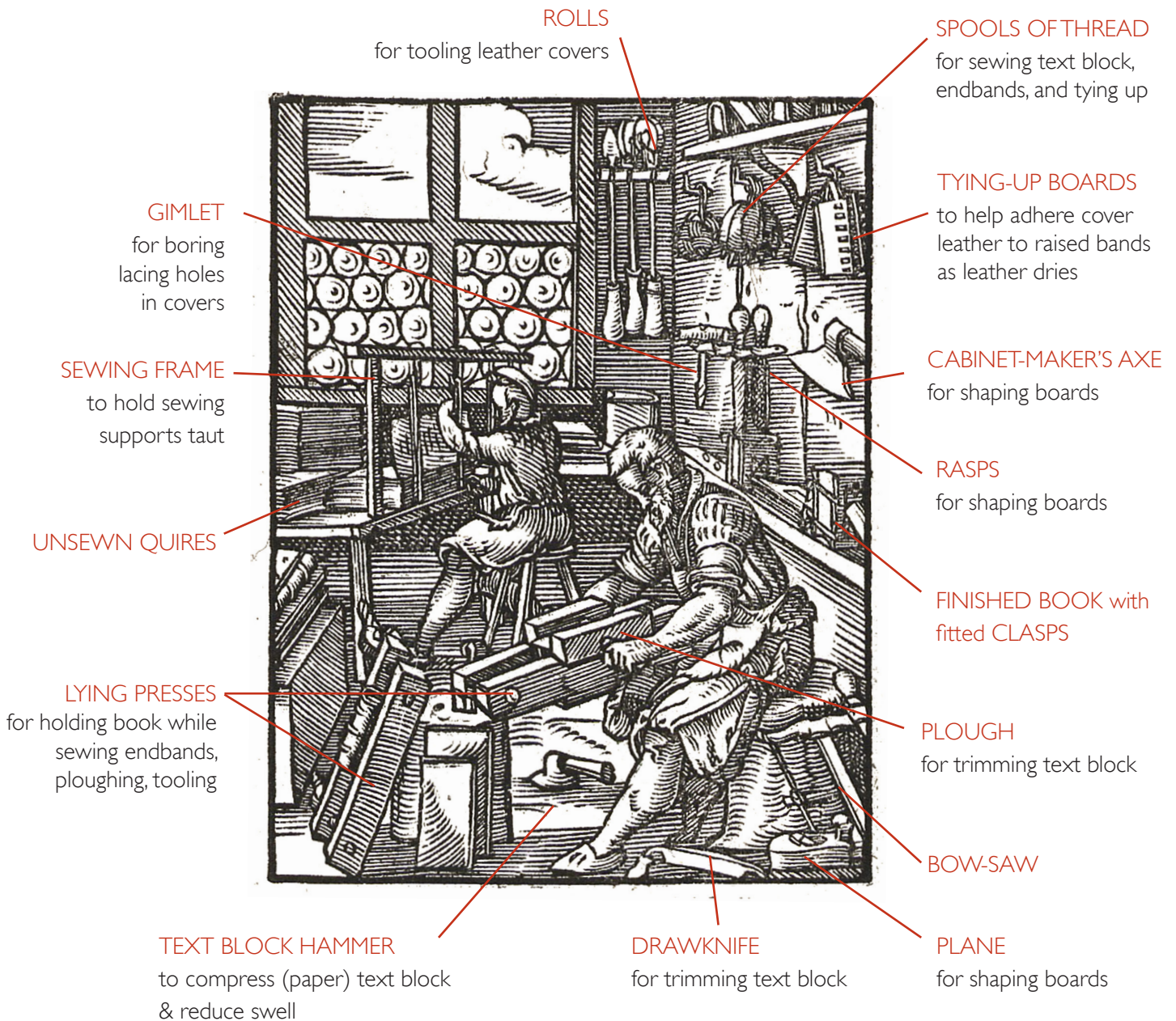

Sewing & Supports

MOST COMMONLY USED FOR MEDIEVAL BINDINGS

ALUM-TAWED SKIN



KETTLE STITCH (LINK- OR CHAIN-STITCH)

SINGLE STRAIGHT SEWING — SLIT BAND

PACKED HERRINGBONE SEWING—DOUBLE BAND

PACKED STRAIGHT SEWING—TWISTED THONG

SINGLE STRAIGHT SEWING—SINGLE BAND

PACKED STRAIGHT SEWING—SINGLE CORD

SINGLE HERRINGBONE SEWING—DOUBLE CORDS

KETTLE STITCH (LINK- OR CHAIN-STITCH)

VEGETABLE FIBER CORDS

Carolingian bindings

8th - 12th c.

Characteristics

CAROLINGIAN

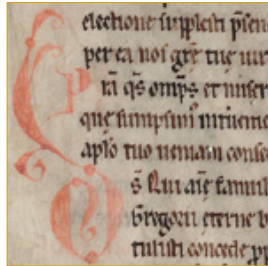

MS 481.108 folio 1R

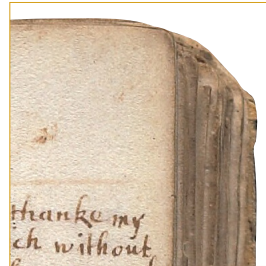

Beinecke MS 331

TEXT BLOCK

Parchment

Flush with boards



Beinecke MS 224



Marston MS 243

SUPPORTS / SEWING

Thin, double cords of vegetable fiber (flax, hemp)

Raised

Herringbone pattern



Beinecke MS 393

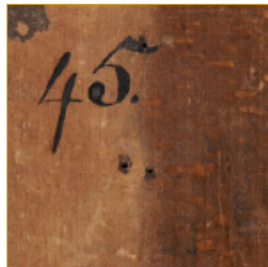

Beinecke MS 688



Beinecke MS 393

BOARDS

Thick

Predominantly oak (also beech, poplar)

Little to no shaping

Same size as text block

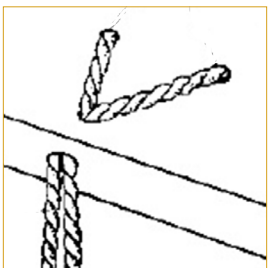

Szirmai Archaeology, 105



Beinecke MS 84

LACING

Through edge of boards

Upper board laced before sewing

Flat spine (not convex)

Note: The manuscripts pictured are used to illustrate characteristic details, but may fall outside the category / date range of Carolingian bindings.

Binding steps

CAROLINGIAN

1. **Prepare boards first:** determine placement of sewing stations; make tunnels and channels to attach sewing supports; chisel recesses for fastenings.
2. **Lace through** vegetable-fiber supports to upper board.
3. **Prepare quires for sewing** by cutting 3-6mm slits into spine folds at predetermined sewing stations (slits were common on insular manuscripts; pierced holes common on continental—often French).
4. **Sew quires to supports**, using a herringbone pattern, beginning with first quire.
5. After last quire is sewn, **lace supports through lower board** and secure by twisting and pegging; trim excess with chisel.
6. Reinforce board attachment by **attaching pastedowns** (generally first leaf of the first quire & last leaf of last quire; usually blank; never manuscript waste).
7. **Trim edges of text block** flush with boards (probably using a drawknife).
8. **Sew endbands** through tab lining.
9. **Construct strap(s)** using same material as book covering.
10. Dampen and **paste out covering leather** (commonly chamois); **adhere to boards** (usually not spine); turn in. Turn-ins will be on top of pastedowns—a characteristic of Carolingian bindings.
11. **Sew perimeter of tab endbands** to adhere tab lining to cover tab.
12. **Cut slit for strap** and feed strap through.
13. **Attach strap(s)** to recess(es) in cover with iron or brass nails through thickness of board.
14. **Attach pin(s)** to edge of lower board.

Romanesque bindings

SECOND HALF OF 11TH - END OF 14TH C.

Characteristics

ROMANESQUE

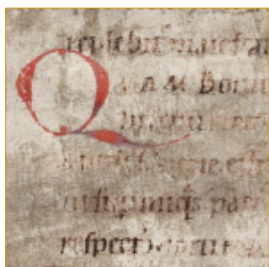
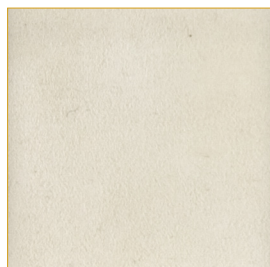

Beinecke MS 481



Beinecke MS 688

TEXT BLOCK

Parchment (thin, sheep)
Flush with boards



Marston MS 93



Marston MS 262

SEWING / SUPPORTS

Thick alum-tawed slit straps
Sewn straight or "packed"
(wrapped multiple times)



Beinecke MS 393

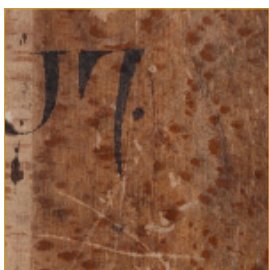

Beinecke MS 873



Beinecke MS 393

BOARDS

Thick
Oak, beech, or poplar
Minimal or no shaping
Same size as text block—
no squares

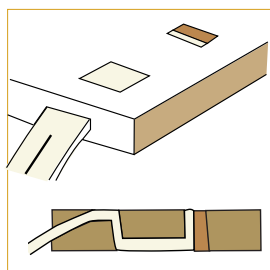

Beinecke MS 393

LACING

Through edge of boards
Flat spine (not convex)
Straight lacing path

Note: The manuscripts pictured are used to illustrate characteristic details, but may fall outside the category / date range of Romanesque bindings.

Binding steps

ROMANESQUE

1. Determine placement of sewing stations; **pierce quires** with awl or sewing needle, or cut slits with knife or chisel.
2. **Sew onto alum-tawed thongs** (usually slit). Sewing could be herringbone pattern (as in Carolingian bindings), single straight sewing, or packed straight sewing.
3. **Prepare wooden boards** by drilling tunnels through spine edge and chiselling/carving out channels and recesses for sewing supports; back-corner to accommodate endbands; shape boards (optional).
4. **Lace ends of sewing supports** through boards; secure with wooden pegs and trim off excess.
5. **Trim edges of text block** flush with boards (probably using a drawknife or chisel).
6. **Add tab linings** for endbands.
7. **Work endbands** through tab linings. Endbands could be herringbone or straight sewing on double supports, possibly with colored thread; plain wound primary; or plain wound primary with secondary embroidered endband in colored linen or silk.
8. **Line spine** (often with chamois leather): full lining; patch linings between sewing supports; lining extending onto inside or outside of boards.
9. **Cover boards** with either chamois/alum-tawed skin or tanned brown leather using starch paste.
10. **Paste down parchment endleaves** over turn-ins. Endleaf construction could vary, but the majority were sewn with the textblock and were often the first and last leaves.
11. If covered with **tanned leather, tool in blind**.
12. *Optional but likely:* Add secondary cover (chemise or overcover).
13. **Add fastenings and furnishings**. Long-strap fastenings are predominant, but could also be Carolingian-style edge fastening).

MS 4

ROMANESQUE / GOTHIC

St. Antonius, Confessionale

154 x 103 (95 x 69) mm

Written in Italy, end of 15th century. Original sewing on three tawed, slit straps, Kermes pink, laced through tunnels in the thickness of wooden boards into rectangular channels on the outer face. Twisted, tawed cores of plain, wound endbands laid in grooves. All supports pegged and gypsum [?] used to fill in around them. Spine lined with brown calf, wanting, except under endband tie-downs. Covered in brown calf, blind-tooled with a rope inter-lace panel border. Corner turn-in tongues. Two catches on lower board, stubs of straps on upper. Boards worm-eaten and detached and most of the cover wanting. Minor repairs to endleaves and headband made ca. 1976.

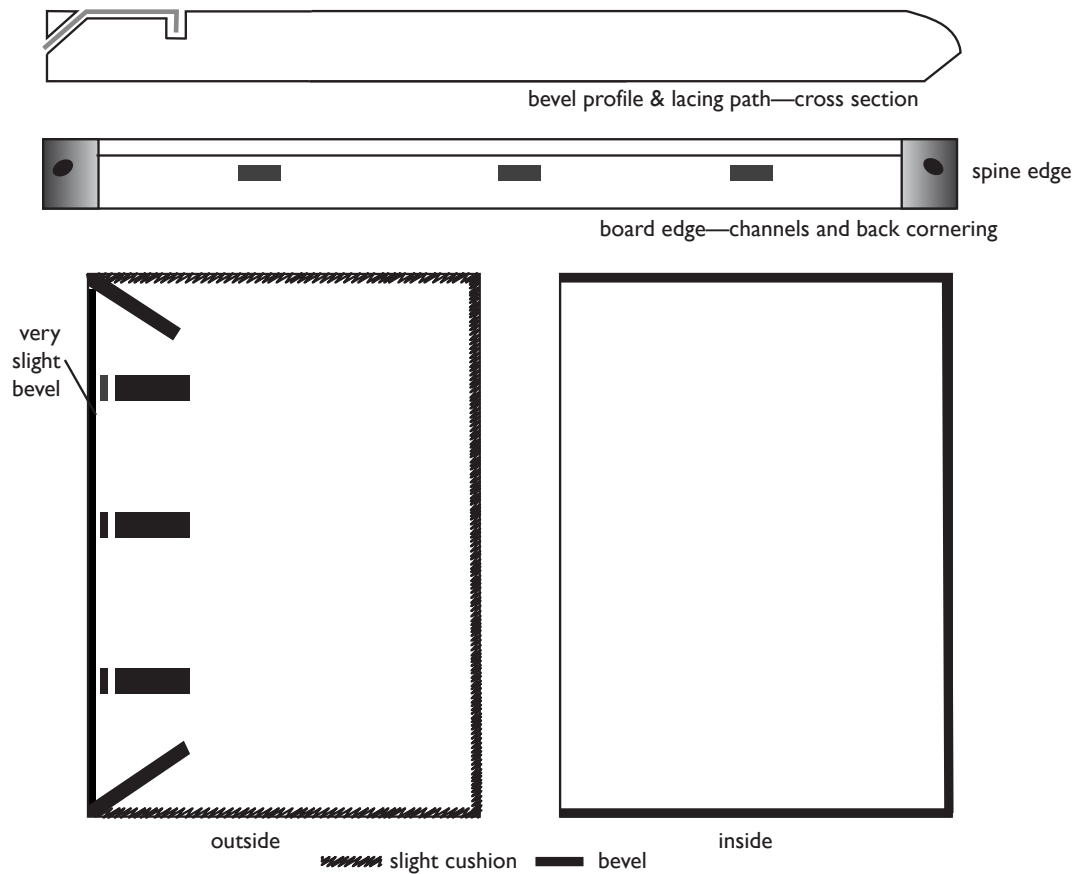

Gothic bindings

EARLY 14TH - 17TH C.

Characteristics

GOTHIC

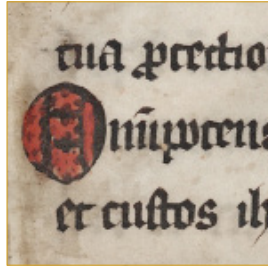

Beinecke MS 481.122 folio 1R



Beinecke MS 287 folio 3r

TEXT BLOCK

Parchment, parchment & paper, or (later) all paper
Smaller than boards



Marston MS 93

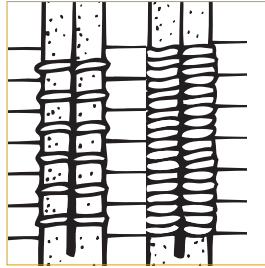

SEWING / SUPPORTS

Alum-tawed skin;
vegetable-fiber cords (later)
Straight or packed sewing
(often "packed" due to thicker sections)



Beinecke MS 710

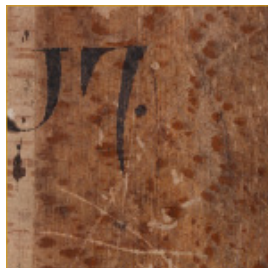

Beinecke MS 873



Beinecke MS 287 folio 24R

BOARDS

Thick
Oak (beech, poplar)
Lots of shaping
Larger than text block
(has squares)

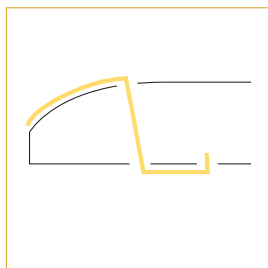

Beinecke MS 417

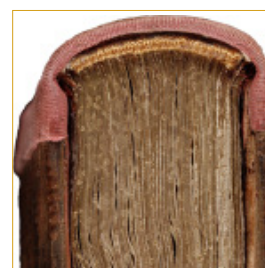

Beinecke MS 287

LACING

Over edge and
through top of boards
Rounded spine
Laced after sewing

Note: The manuscripts pictured are used to illustrate characteristic details, but may fall outside the category / date range of Gothic bindings.

Binding steps

GOTHIC

1. If paper was used for quires, reinforce the inner centerfolds with parchment stays (*optional—some binders were initially suspicious of paper, believing it lacked strength and would need reinforcement to be sewn*).
2. **Add endleaves** to textblock. Endleaves are almost always parchment; often manuscript waste. Endleaf attachment varies widely.
3. Decide number of sewing supports and placement of sewing stations; **cut or pierce holes for sewing**.
4. **Decide material of sewing supports**: vegetable fiber cords (single or double) or alum-tawed skin (slit thong; intertwisted slit thong; double thong, loosely or tightly twisted single or double thongs).
5. **Sew quires onto supports**—either herringbone (single or packed), straight, or packed. To save time, endbands can be sewn along with quires (integral sewing).
6. **Consolidate spine** with adhesive (hide glue).

Optional: do not glue up spine.

7. **Round spine with backing hammer** if text block is paper (*to compensate for “swelling” of text block from sewing thread. Parchment’s tendency to cockle cancelled out any swelling from sewing thread, so mechanical rounding with hammer was generally not needed*).
8. **Line spine** with parchment, leather, or chamois (patch; transverse; slotted; comb).

Optional: do not line spine.

9. **Trim edges of textblock** (with drawknife; with plough after first quarter of 16th century).

Optional but not common: decorate edges (paint; stain; gild; gauffer).

10. If not sewn integrally, **work endbands** now. Endbands varied: primary plain wound; saddlestitch over primary wound; primary wound plus secondary embroidery in colored linen or silk (“Renaissance” endband); primary wound with secondary braiding; primary embroidered in colored linen or silk; “short-cut” (stuck-on).
11. **Prepare boards**: shape and prepare tunnels & channels for lacing and clasps. Board edge shapes varied widely (rounded; beveled; chamfered; partially chamfered; beveled and chamfered; rounded and beveled, etc.), as did lacing path patterns (straight, staggered, V-shape, or any combination).
12. **Lace ends of sewing supports into boards**; peg.
13. **Cover boards** in dampened leather (usually tanned or tawed) with starch paste or combination of paste/animal hide glue. Could also be covered in precious textiles, primarily or secondarily (see below).

14. “Tie up” raised bands with cords to adhere damp leather firmly around raised supports while drying.

Optional:

- Stain alum-tawed leather, either before or after covering (sap green, saffron, brazilwood, iron-gall ink, verdigris...).
 - Decorate/tool tanned leather.
 - Add overcover (leather overcover; precious textile chemise; girdle book; overback).
15. Attach fastenings (long-strap; hook-clasp) and any furnishings: corner pieces, center pieces, bosses, shoes, heels, title windows (*fenestra*), edge strips, skids, chains.

MS 84

GOTHIC (GIRDLE BOOK)

Boethius: *De consolatione philosophiae*.

100 x 80 (68 x 41) mm

Binding circa 15th century, possibly German or Dutch. Although early, it is not the original binding. Resewn on three narrow, tawed double thongs. The endbands do not seem to have laced cores, but a primary sewing may have been sewn to the head and tail of the chemise, underneath the braided secondary endbands. The thongs are laced into grooves in beech boards, the pattern reversed; one horizontal above one V lacing on the upper board and a V above a horizontal on the lower. The thongs are pegged. The outer wrapper of tawed skin, now grey, is sewn to a tawed, pin, inner chemise around the outer edges of the boards. The wrapper extends about 130 mm to a Turk's head knot at the tail, about 25 mm at the head, and has an overlap of about 50 mm on the upper board. The edges of the wrapper are turned in and hemmed. The book hung upside down when attached to the girdle by having the knot slipped under it, but was right side up when picked up (still attached to the girdle) to be read. A strap-and-pin fastening, the pin on the upper board, consists of a thick, brown leather strap nailed to the lower board and tacketed to the cover with a leather thong ending in an anthropomorphic brass clasp, the head of which catches on the pin.



outer front

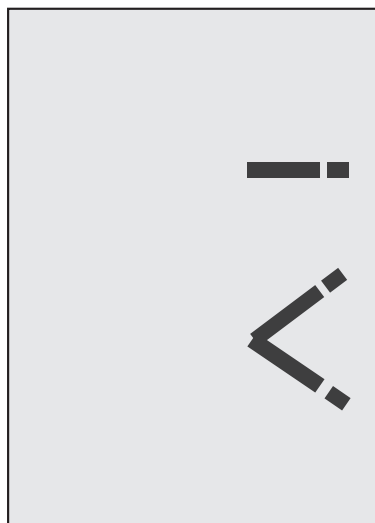

inner front

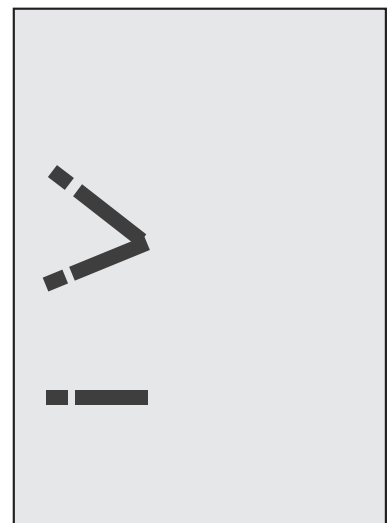

inner back

Limp bindings

MS 610

LIMP PARCHMENT (LACED)

Bouche of Courte.

305 x 205 mm

Limp parchment with remains of leather ties. Manuscript on paper.

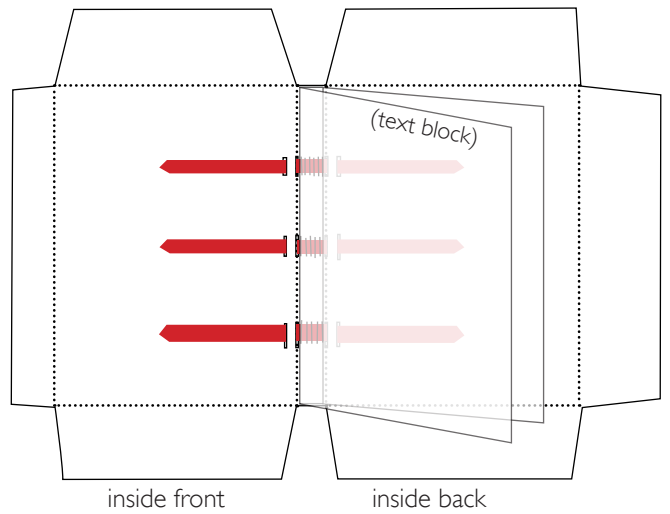
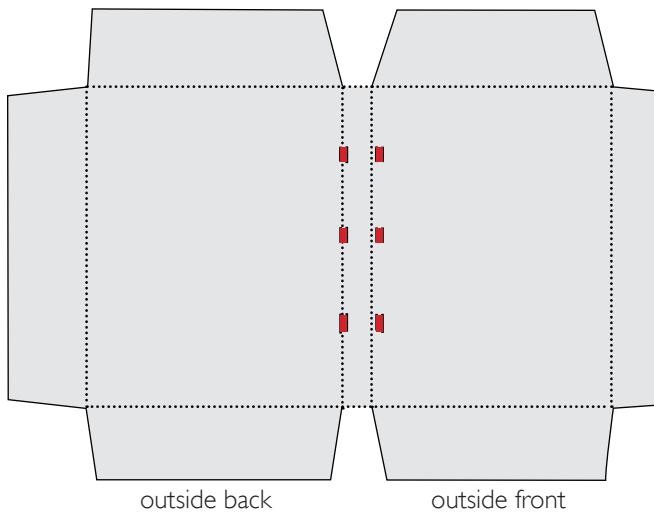

..... fold
— alum-tawed slips*



*not to scale: width of slips enlarged for clarity

Bibliography

GENERAL

- Cambridge Histories Online. *Cambridge History of the Book in Britain Volumes I-III*. Cambridge University Press, 2012. AVAILABLE ONLINE AT: <http://www.universitypublishingonline.org/cambridge/histories>
- Gillespie, Alexandra and Daniel Wakelin, Ed. *The Production of Books in England 1350–1500*. New York: Cambridge University Press, 2011.
- Needham, Paul. *Twelve Centuries of Bookbindings: 400-1600*. New York: Oxford University Press, 1979.
- Roberts, Jane and Pamela Robinson. *The History of the Book in the West: 400 AD-1455, Volume 1*. Farnham: Ashgate, 2011.

TERMINOLOGY

- Gnirrep, W.K., J.P. Gumbert, and J.A. Szirmai. *Kneep e Binding: een terminologie voor de beschrijving van de constructies van oude boekbanden*. The Hague: CIP-Gegevens Koninklijke Bibliotheek, 1993
- PDF AVAILABLE ONLINE AT: www.kb.nl/expertise/conservering/kneep-en-binding-digitale-versie
- Roberts, Matt T. and Don Etherington. *Bookbinding and the Conservation of Books, a dictionary of descriptive terminology*. Washington: Library of Congress, 1982. (While not limited to the medieval period, still a useful reference.) AVAILABLE ONLINE AT: www.cool.conservation-us.org/don/don.html

MATERIALS

- Burns, Claire. "The Tanning Industry of Medieval Britain" in *The Collegiate Journal of Anthropology, Vol. 1*. Friday, June 15, 2012. <http://anthrojournal.com/issue/october-2011/article/the-tanning-industry-of-medieval-britain>
- Clarkson, Christopher. "Rediscovering Parchment: The Nature of the Beast," *The Paper Conservator*, 16:1, 5-2, 1992.
- Federici, Carlo, Anna di Majo, and Marco Palma. "The Determination of Animal Species Used in Medieval Parchment Making: Non-Destructive Identification Techniques" in *Roger Powell: The Compleat Binder, Liber Amicorum, Bibliologia 14*. ed. J.L. Sharpe. Turnhout: Brepols, 1996, 146-153.
- Gameson, Richard. "The material fabric of early British books" in *The Cambridge History of the Book in Britain Volume II: 1100-1400*, Cambridge University Press, 2012, 13-93.
- Vest, Marie. "The production and use of alum-tawed leather in the Middle Ages and later" in *Care and conservation of manuscripts 5, Proceedings of the fifth international seminar held at the University of Copenhagen 19th-20th April 1999*. ed. by Gillian Fellows-Jensen and Peter Springborg. Copenhagen: The Royal Library, 2000, 16-20.

BOOKBINDING STRUCTURES & TECHNIQUES

GENERAL

Frost, Gary. "Mobility and Function in the Codex Bookbinding" in *Roger Powell: The Compleat Binder; Liber Amicorum, Bibliologia 14*. ed. J.L. Sharpe. Turnhout: Brepols, 1996, 92-100.

Middleton, Bernard. *A History of English Craft Bookbinding Technique*. New York & London: Hafner Publishing Company, 1978.

Szirmai, J.A. *The Archaeology of Medieval Bookbinding*. Aldershot: Ashgate, 1999.

van Regemorter, Berthe. *Binding Structures in the Middle Ages: A Selection of Studies*. Translated and annotated by Jane Greenfield. Brussels: Bibliotheca Wittockiana, 1992.

CAROLINGIAN & EARLIER BINDINGS

Clarkson, Christopher. "Further Studies in Anglo-Saxon and Norman Bookbinding: Board Attachment Methods Re-examined" in *Roger Powell: The Compleat Binder; Liber Amicorum, Bibliologia 14*. ed. J.L. Sharpe. Turnhout: Brepols, 1996, 154-214.

Gullick, Michael. "Bookbindings" in *The Cambridge History of the Book in Britain Volume I: 400-1100*. Cambridge University Press, 2012, 294-309.

Szirmai, J.A. "Carolingian Bindings" in *The Archaeology of Medieval Bookbinding*. Aldershot: Ashgate, 1999, 99-139.

ROMANESQUE BINDINGS

Clarkson, Christopher. "A Hitherto Unrecorded English Romanesque Book Sewing Technique" in *Roger Powell: The Compleat Binder; Liber Amicorum, Bibliologia 14*. ed. J.L. Sharpe. Turnhout: Brepols, 1996, 215-239.

— "English Monastic Bookbinding in the Twelfth Century", in *Ancient and Medieval Book Materials and Techniques: Erice, 18-25 September 1992*. ed. Marilena Maniaci and Paola F. Munafò. Città del Vaticano: Biblioteca Apostolica Vaticana, 1993, 181-200.

Gullick, Michael. "Bookbindings" in *The Cambridge History of the Book in Britain Volume I: 400-1100*. Cambridge University Press, 2012, 294-309.

— "From Scribe to Binder: Quire Tackets in Twelfth Century European Manuscripts" in *Roger Powell: The Compleat Binder; Liber Amicorum, Bibliologia 14*. ed. J.L. Sharpe. Turnhout: Brepols, 1996, 240-259.

Pollard, Graham. "The construction of English 12th century bindings" in *The Library, Fifth Series, Vol 17, No. 1, March 1962*, 1-22.

Szirmai, J.A. "Romanesque bindings" in *The Archaeology of Medieval Bookbinding*. Aldershot: Ashgate, 1999, 140-172.

GOTHIC BINDINGS

- Bearman, Frederick. "The Origins and Significance of Two Late Medieval Textile Chemise Bookbindings in the Walters Art Gallery" in *Journal of the Walters Art Gallery, Vol 54, Essays in Honor of Lilian M. C. Randall*. The Walters Art Museum, 1996, 163-187.
- Gullick, Michael and Nicholas Hadgraft. "Bookbindings" in *Cambridge History of the Book in Britain, Volume II: 1100-1400*. Cambridge University Press, 2000, 95-109.
- Foot, M.M. "Bookbinding 1400-1557" in *The Cambridge History of the Book in Britain Volume III: 1400-1557*, Cambridge University Press, 2012, 109-127.
- Szirmai, J.A. "Gothic bindings" in *The Archaeology of Medieval Bookbinding*. Aldershot: Ashgate, 1999, 173-284.

LIMP BINDINGS

- Szirmai, J.A. "Limp bindings" in *The Archaeology of Medieval Bookbinding*. Aldershot: Ashgate, 1999, 285-319.

CHEMISE BINDINGS, GIRDLE BOOKS

- Bearman, Frederick. "The Origins and Significance of Two Late Medieval Textile Chemise Bookbindings in the Walters Art Gallery" in *Journal of the Walters Art Gallery, Vol 54, Essays in Honor of Lilian M. C. Randall*. The Walters Art Museum, 1996, 163-187.
- Greenfield, Jane. "Consolatione Philosophiae" in *The Yale University Library Gazette, Vol. 77, No. 1/2*. New Haven: Yale University, 2002, 91-93.
- van Leeuwen, Jan Storm. "The Well-Shirted Bookbinding: On Chemise Bindings and Hülle-neinbände," in *Theatrum Orbis Librorum: Liber Amicorum, Presented to Nico Israel on the Occasion of His Seventieth Birthday*. ed. T. Croiset van Uchelen et al. Utrecht: 1989, 277-305.

ENDBANDS

- Bibliothèque Nationale, Service de la conservation et de la restauration. *Les tranche-fiches brodées: étude historique et technique*. Paris: Bibliothèque Nationale, 1989, 14-49.
- Gast, Monika. "A History of Endbands based on a study by Karl Jäckel" in *The New Bookbinder: Journal of Designer Bookbinders, Vol. 3*. London (?): Designer Bookbinders, 1983, 42-58.
- Giuffrida, B. "Book Conservation Workshop Manual, Part Three: Endbands" in *The New Bookbinder: Journal of Designer Bookbinders, Vol. 2*. London(?): Designer Bookbinders, 1982, 29-39.

BOOK STORAGE AND LIBRARY FURNITURE

- Streeter, Burnett Hillman. *The Chained Library. A Survey of Four Centuries in the Evolution of the English Library*. New York: Burt Franklin, 1970 (reprint).
- Smith, Janet Charlotte. "The Side Chambers of San Giovanni Evangelista in Ravenna: Church Libraries of the Fifth Century" in *Gesta*, Vol. 29, No. 1. University of Chicago Press on behalf of the International Center of Medieval Art, 1990, pp.86-97.



*Special Collections Conservation
Preservation Department, Yale University Library*

July 2015

*Above image: A monk using a sewing frame. 12th century. Bamberg, Staatsbibliothek, MS Patr. 5, fol. IV.
Cover image: Beinecke Rare Book & Manuscript Library, Beinecke MS 866.*